

1GHz, 4 x 1 Multiplexing Amplifier

The ISL59442 is a single-output 4:1 MUX-amp. The MUX-amp has a fixed gain of 1 and a 1GHz bandwidth. The device contains logic inputs for channel selection (S0, S1), and a three-state output control (HIZ) for individual selection of MUX amps that share a common video output line. All logic inputs have pull-downs to ground and may be left floating.

TABLE 1. TRUTH TABLE

HIZ	S1	S0	OUT
0	0	0	IN0
0	0	1	IN1
0	1	0	IN2
0	1	1	IN3
1	X	X	HIZ

Pinout

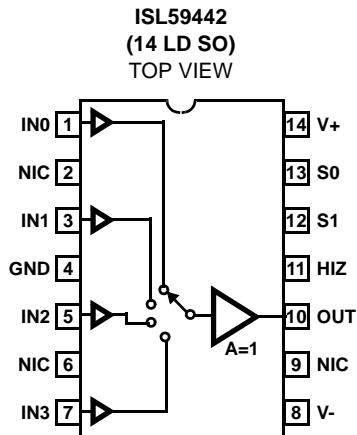

Features

- 1GHz (-3dB) Bandwidth ($V_{OUT} = 200mV_{P-P}$)
- 235MHz (-3dB) Bandwidth ($V_{OUT} = 2V_{P-P}$)
- Slew Rate ($R_L = 525\Omega, V_{OUT} = 5V$) 1452V/ μs
- High Speed Three-state Output (HIZ)
- Pb-Free Plus Anneal Available (RoHS Compliant)

Applications

- HDTV/DTV Analog Inputs
- Video Projectors
- Computer Monitors
- Set-top Boxes
- Security Video
- Broadcast Video Equipment

Functional Diagram

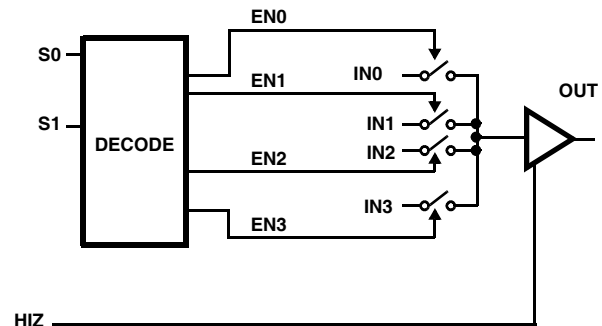

Ordering Information

PART NUMBER	PART MARKING	TAPE & REEL	PACKAGE	PKG. DWG. #
ISL59442IB	59442IB	-	14 Ld SOIC	MDP0027
ISL59442IB-T7	59442IB	7"	14 Ld SOIC	MDP0027
ISL59442IB-T13	59442IB	13"	14 Ld SOIC	MDP0027
ISL59442IBZ (Note)	59442IBZ	-	14 Ld SOIC (Pb-free)	MDP0027
ISL59442IBZ-T7 (Note)	59442IBZ	7"	14 Ld SOIC (Pb-free)	MDP0027
ISL59442IBZ-T13 (Note)	59442IBZ	13"	14 Ld SOIC (Pb-free)	MDP0027

NOTE: Intersil Pb-free plus anneal products employ special Pb-free material sets; molding compounds/die attach materials and 100% matte tin plate termination finish, which are RoHS compliant and compatible with both SnPb and Pb-free soldering operations. Intersil Pb-free products are MSL classified at Pb-free peak reflow temperatures that meet or exceed the Pb-free requirements of IPC/JEDEC J STD-020.

Absolute Maximum Ratings ($T_A = +25^\circ\text{C}$)

Supply Voltage (V_+ to V_-)	11V	Storage Temperature Range	-65°C to +150°C
Input Voltage	$V_- -0.5\text{V}$, $V_+ +0.5\text{V}$	Ambient Operating Temperature	-40°C to 85°C
Supply Turn-on Slew Rate	1V/ μs	Operating Junction Temperature	-40°C to +125°C
Digital and Analog Input Current (Note 1)	50mA	Power Dissipation	See Curves
Output Current (Continuous)	50mA	θ_{JA}	See Curves
ESD Rating			
Human Body Model (Per MIL-STD-883 Method 3015.7)	3kV		
Machine Model	300V		

CAUTION: Stresses above those listed in "Absolute Maximum Ratings" may cause permanent damage to the device. This is a stress only rating and operation of the device at these or any other conditions above those indicated in the operational sections of this specification is not implied.

NOTE:

1. If an input signal is applied before the supplies are powered up, the input current must be limited to these maximum values.

IMPORTANT NOTE: All parameters having Min/Max specifications are guaranteed. Typical values are for information purposes only. Unless otherwise noted, all tests are at the specified temperature and are pulsed tests, therefore: $T_J = T_C = T_A$

Electrical Specifications $V_+ = +5\text{V}$, $V_- = -5\text{V}$, $\text{GND} = 0\text{V}$, $T_A = +25^\circ\text{C}$, Input Video = 1V_{P-P} and $R_L = 500\Omega$ to GND, $V_{HIZ} = 0.8\text{V}$, Unless Otherwise Specified

PARAMETER	DESCRIPTION	CONDITIONS	MIN	TYP	MAX	UNIT
GENERAL						
I _S	Supply Current ($V_{OUT} = 0\text{V}$)	No load, $V_{HIZ} = 0.8\text{V}$	14.5	18	20	mA
		No load, $V_{HIZ} = 2.0\text{V}$	12	15.5	17.5	mA
V _{OUT}	Positive and Negative Output Swing	$V_{IN} = \pm 3.5\text{V}$, $R_L = 500\Omega$	± 3.2	± 3.44		V
I _{OUT}	Output Current	$R_L = 10\Omega$ to GND	± 80	± 120	± 180	mA
V _{OS}	Output Offset Voltage		-2	9	20	mV
I _b	Input Bias Current	$V_{IN} = 0\text{V}$	-5	-2.5	-1	μA
R _{out}	Output Resistance	HIZ = logic high, (DC)		1.4		M Ω
		HIZ = logic low, (DC)		0.2		Ω
R _{IN}	Input Resistance	$V_{IN} = \pm 3.5\text{V}$		10		M Ω
A _{CL} or A _v	Voltage Gain	$V_{IN} = \pm 1.5\text{V}$, $R_L = 500\Omega$	0.999	1.001	1.003	V/V
I _{TRI}	Output Current in Three-state	$V_{OUT} = 0\text{V}$	-35	6	35	μA
LOGIC						
V _H	Input High Voltage (Logic Inputs)		2			V
V _L	Input Low Voltage (Logic Inputs)				0.8	V
I _{IH}	Input High Current (Logic Inputs)		50	90	150	μA
I _{IL}	Input Low Current (Logic Inputs)			2		μA
AC GENERAL						
-3dB BW	-3dB Bandwidth	$V_{OUT} = 200\text{mV}_{P-P}$, $C_L = 1.6\text{pF}$		1.0		GHz
		$V_{OUT} = 2\text{V}_{P-P}$, $C_L = 23.6\text{pF}$, $R_S = 25\Omega$		235		MHz
0.1dB BW	0.1dB Bandwidth	$V_{OUT} = 200\text{mV}_{P-P}$, $C_L = 1.6\text{pF}$		100		MHz
		$V_{OUT} = 2\text{V}_{P-P}$, $C_L = 23.6\text{pF}$, $R_S = 25\Omega$		35		MHz
dG	Differential Gain Error	NTC-7, $R_L = 150$		0.01		%
dP	Differential Phase Error	NTC-7, $R_L = 150$		0.02		°
+SR	Slew Rate	25% to 75%, $V_{OUT} = 5\text{V}$, $R_L = 525\Omega$, $C_L = 23.6\text{pF}$		1452		V/ μs
-SR	Slew Rate	25% to 75%, $V_{OUT} = 5\text{V}$, $R_L = 525\Omega$, $C_L = 23.6\text{pF}$		1124		V/ μs

ISL59442

Electrical Specifications $V_+ = +5V$, $V_- = -5V$, $GND = 0V$, $T_A = +25^\circ C$, Input Video = $1V_{p-p}$ and $R_L = 500\Omega$ to GND , $V_{HIZ} = 0.8V$, Unless Otherwise Specified **(Continued)**

PARAMETER	DESCRIPTION	CONDITIONS	MIN	TYP	MAX	UNIT
PSRR	Power Supply Rejection Ratio	DC, PSRR V_+ and V_- combined $V_{\pm} = \pm 4.5V$ to $\pm 5.5V$	-50	-57		dB
ISO	Channel Isolation	$f = 10MHz$, Ch-Ch X-Talk and Off Isolation, $C_L = 1.6pF$		75		dB
SWITCHING CHARACTERISTICS						
V_{GLITCH}	Channel-to-Channel Switching Glitch	$V_{IN} = 0V$, $C_L = 23.6pF$, $R_S = 25\Omega$		2		mV_{p-p}
	HIZ Switching Glitch	$V_{IN} = 0V$, $C_L = 23.6pF$, $R_S = 25\Omega$		135		mV_{p-p}
t_{SW-L-H}	Channel Switching Time Low to High	1.2V logic threshold to 10% movement of analog output		30		ns
t_{SW-H-L}	Channel Switching Time High to Low	1.2V logic threshold to 10% movement of analog output		28		ns
TRANSIENT RESPONSE						
t_r, t_f	Rise and Fall Time, 10% to 90%	$V_{OUT} = 200mV_{p-p}$, $C_L = 1.6pF$		0.69		ns
		$V_{OUT} = 2V_{p-p}$, $C_L = 23.6pF$, $R_S = 25\Omega$		1.4		ns
t_s	0.1% Settling Time	$V_{OUT} = 2V_{p-p}$, $C_L = 23.6pF$, $R_S = 25\Omega$		6.6		ns
t_{PLH}	Propagation Delay - Low to High, 10% to 10%	$V_{OUT} = 200mV_{p-p}$, $C_L = 1.6pF$		0.46		ns
		$V_{OUT} = 2V_{p-p}$, $C_L = 23.6pF$, $R_S = 25\Omega$		0.92		ns
t_{PHL}	Propagation Delay- High to Low, 10% to 10%	$V_{OUT} = 200mV_{p-p}$, $C_L = 1.6pF$		0.52		ns
		$V_{OUT} = 2V_{p-p}$, $C_L = 23.6pF$, $R_S = 25\Omega$		0.97		ns
O_S	Overshoot	$V_{OUT} = 200mV_{p-p}$, $C_L = 1.6pF$		8.3		%
		$V_{OUT} = 2V_{p-p}$, $C_L = 23.6pF$, $R_S = 25\Omega$		13.3		%

Typical Performance Curves $V_S = \pm 5V$, $R_L = 500\Omega$ to GND , $T_A = +25^\circ C$, unless otherwise specified.

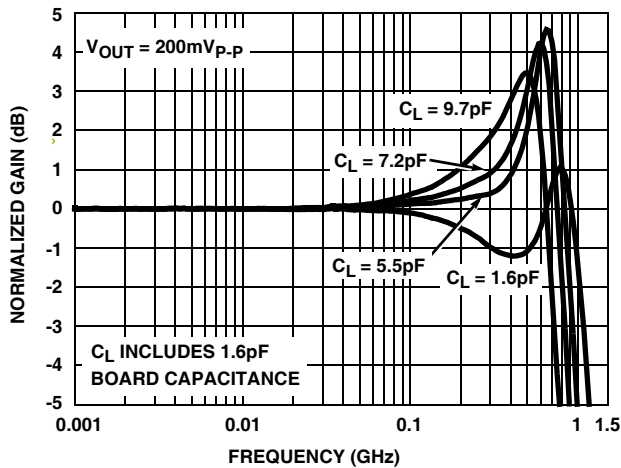

FIGURE 1. SMALL SIGNAL GAIN vs FREQUENCY vs C_L

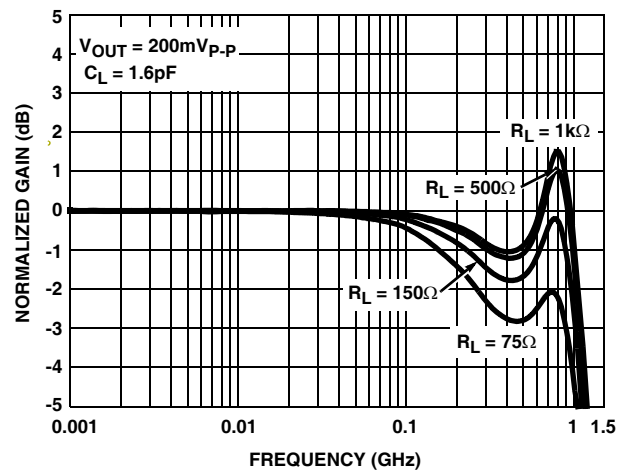

FIGURE 2. SMALL SIGNAL GAIN vs FREQUENCY vs R_L

Typical Performance Curves $V_S = \pm 5V$, $R_L = 500\Omega$ to GND, $T_A = +25^\circ C$, unless otherwise specified. (Continued)

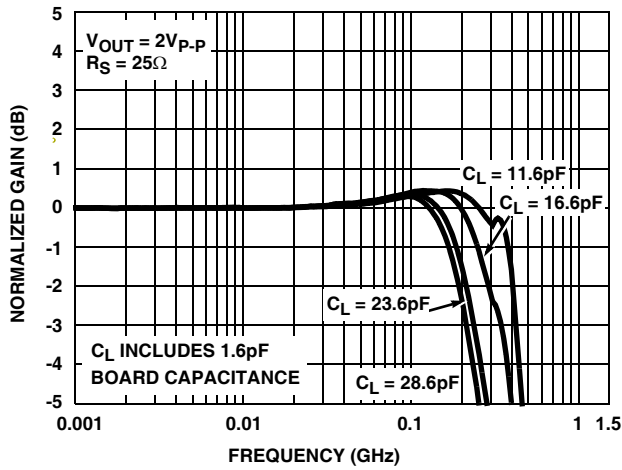

FIGURE 3. LARGE SIGNAL GAIN vs FREQUENCY vs C_L

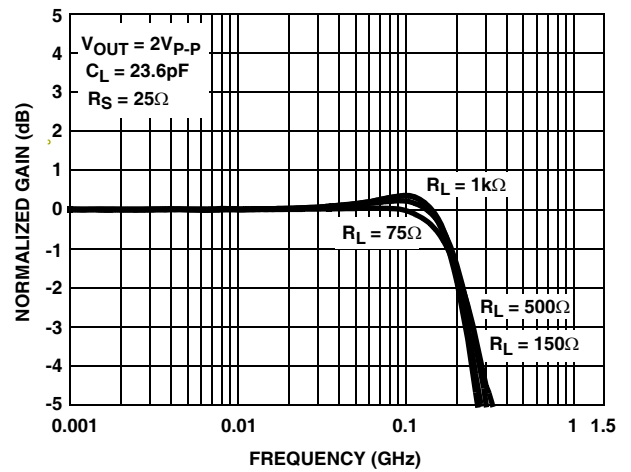

FIGURE 4. LARGE SIGNAL GAIN vs FREQUENCY vs R_L

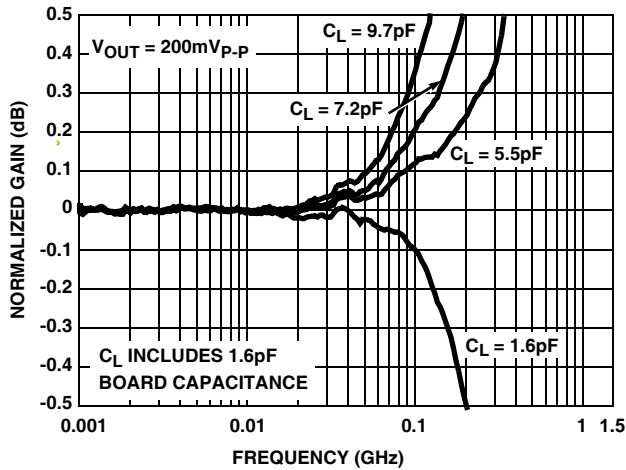

FIGURE 5. SMALL SIGNAL 0.1dB GAIN vs FREQUENCY vs C_L

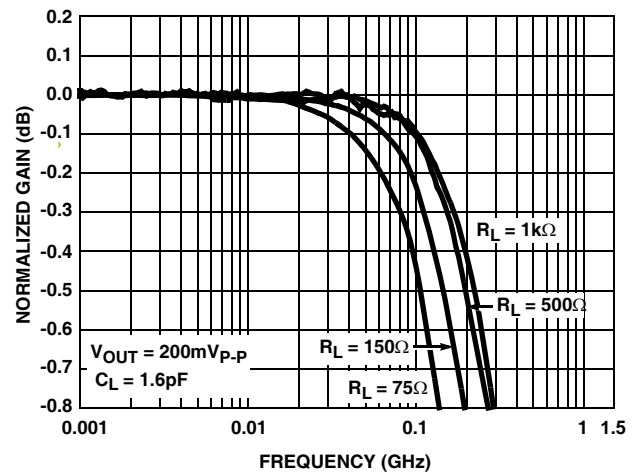

FIGURE 6. SMALL SIGNAL 0.1dB GAIN vs FREQUENCY vs R_L

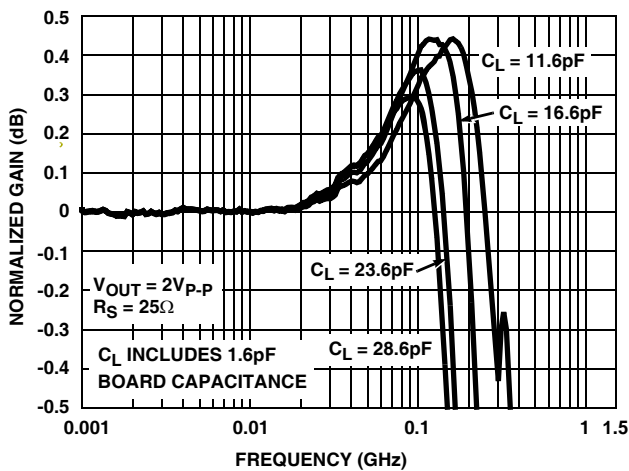

FIGURE 7. LARGE SIGNAL 0.1dB GAIN vs FREQUENCY vs C_L

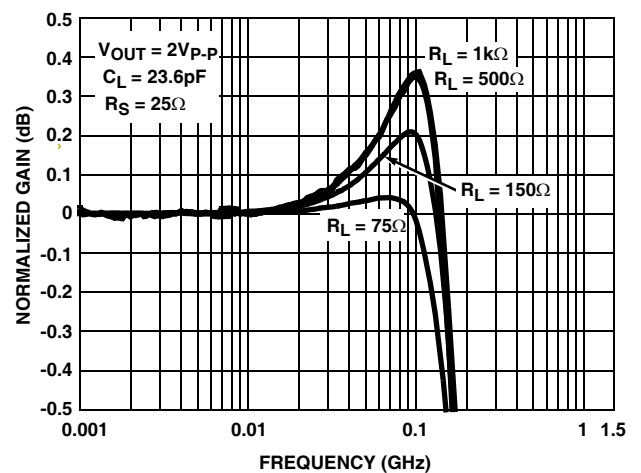

FIGURE 8. LARGE SIGNAL 0.1dB GAIN vs FREQUENCY vs R_L

Typical Performance Curves $V_S = \pm 5V$, $R_L = 500\Omega$ to GND, $T_A = +25^\circ C$, unless otherwise specified. (Continued)

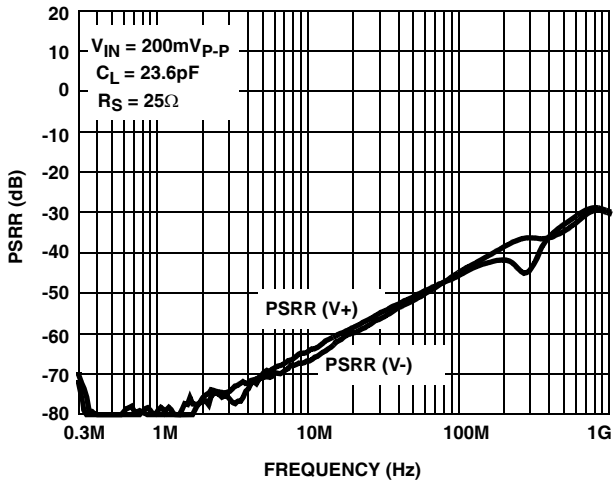

FIGURE 9. PSRR CHANNELS

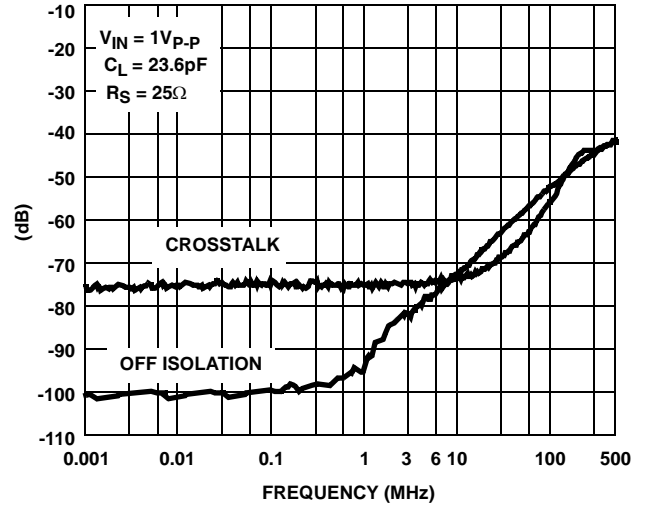

FIGURE 10. CROSSTALK AND OFF ISOLATION

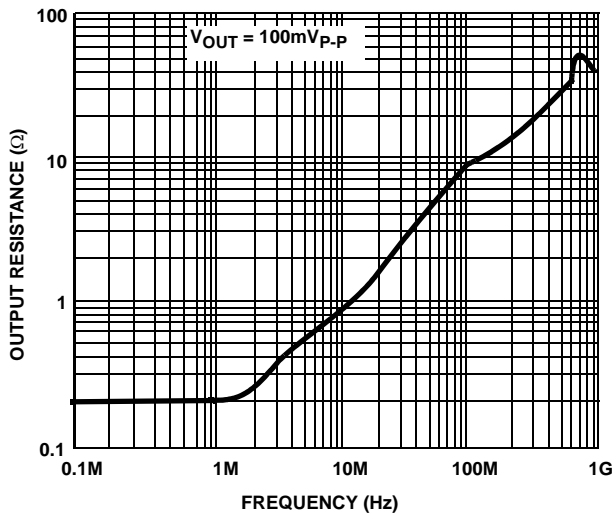

FIGURE 11. R_{OUT} vs FREQUENCY

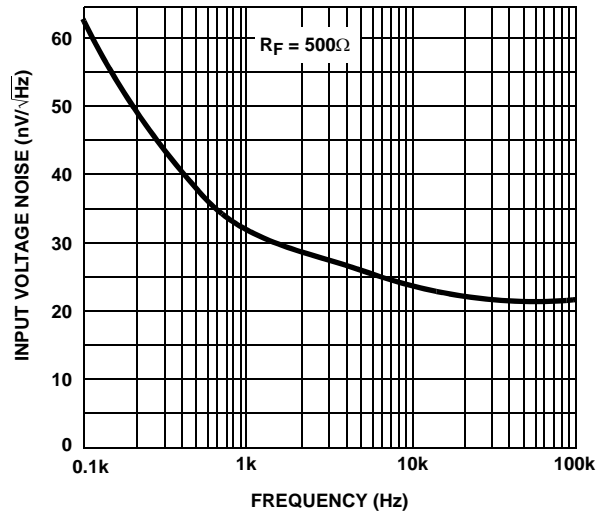

FIGURE 12. INPUT NOISE vs FREQUENCY

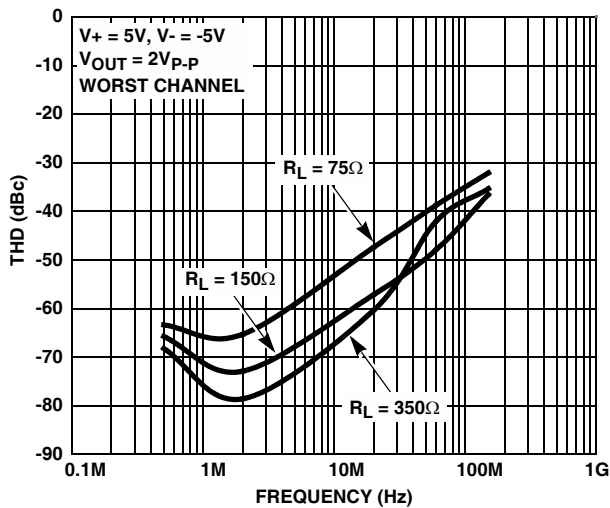

FIGURE 13. THD vs FREQUENCY

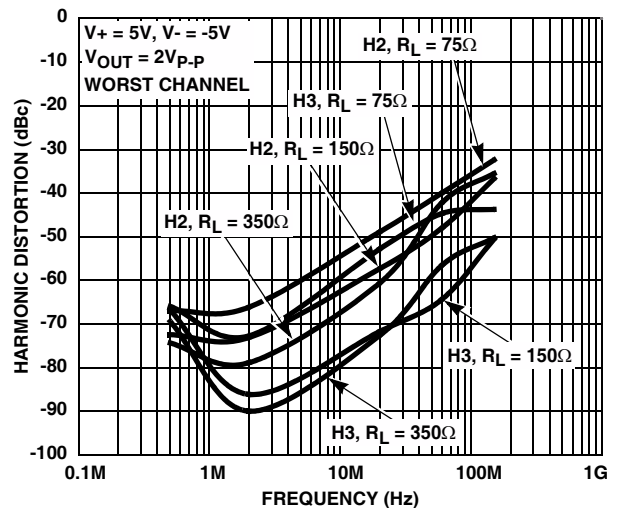

FIGURE 14. HARMONIC DISTORTION vs FREQUENCY

Typical Performance Curves $V_S = \pm 5V$, $R_L = 500\Omega$ to GND, $T_A = +25^\circ C$, unless otherwise specified. (Continued)

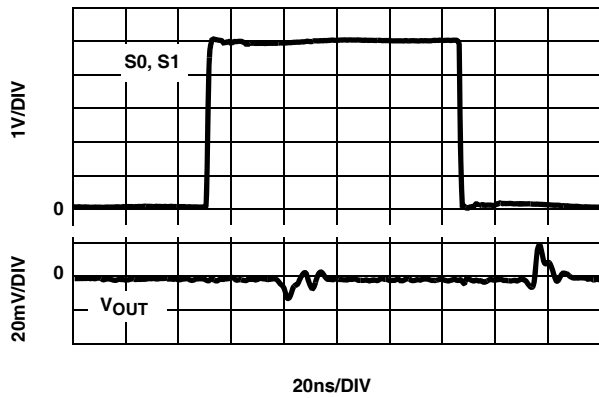

FIGURE 15. CHANNEL TO CHANNEL SWITCHING GLITCH
 $V_{IN} = 0V$, $R_S = 25$, $C_L = 23.6pF$

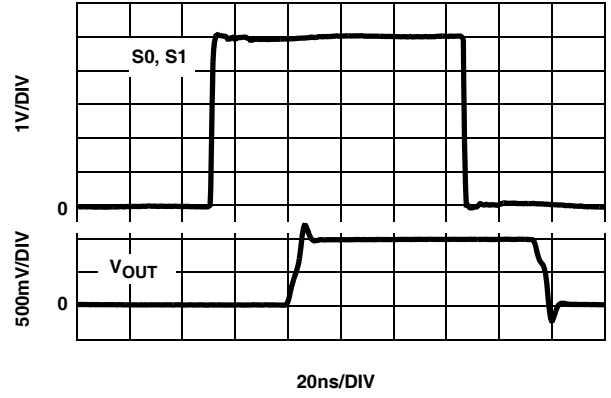

FIGURE 16. CHANNEL TO CHANNEL TRANSIENT RESPONSE
 $V_{IN} = 1V$, $R_S = 25$, $C_L = 23.6pF$

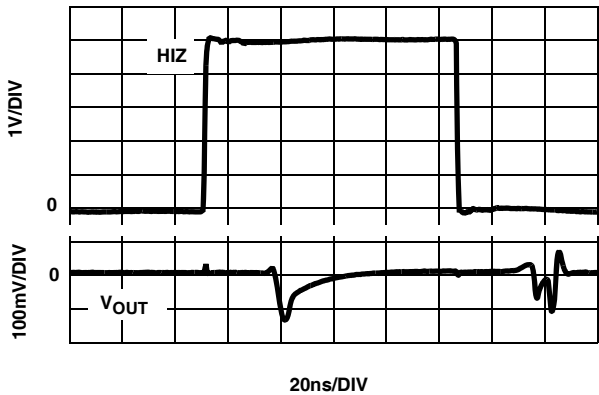

FIGURE 17. HIZ SWITCHING GLITCH $V_{IN} = 0V$, $R_S = 25$,
 $C_L = 23.6pF$

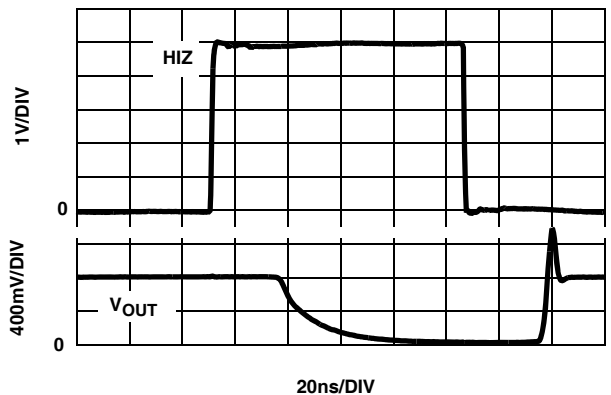

FIGURE 18. HIZ TRANSIENT RESPONSE $V_{IN} = 1V$, $R_S = 25$,
 $C_L = 23.6pF$

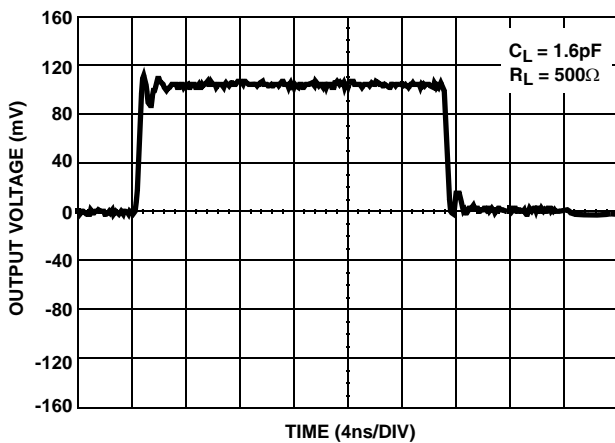

FIGURE 19. SMALL SIGNAL TRANSIENT RESPONSE

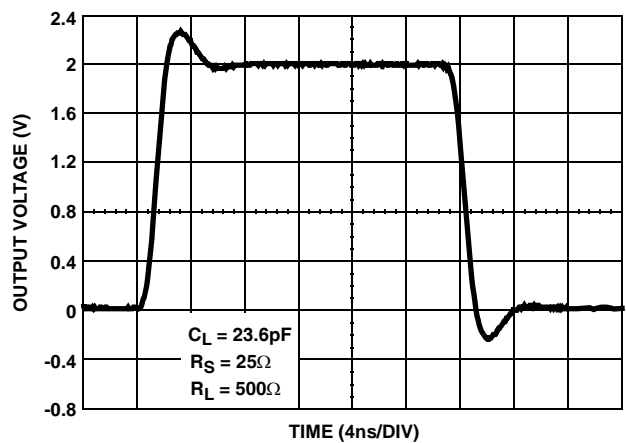

FIGURE 20. LARGE SIGNAL TRANSIENT RESPONSE

Typical Performance Curves $V_S = \pm 5V$, $R_L = 500\Omega$ to GND, $T_A = +25^\circ C$, unless otherwise specified. (Continued)

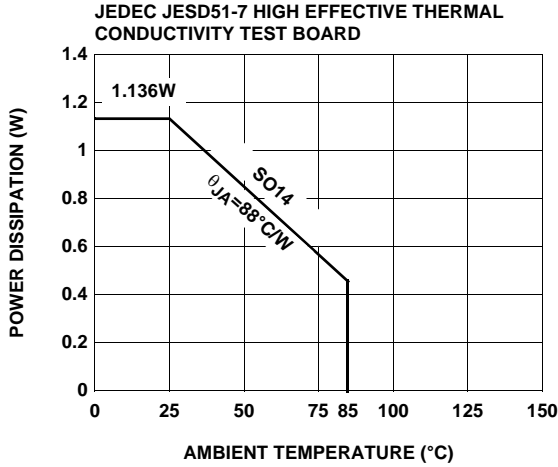

FIGURE 21. PACKAGE POWER DISSIPATION vs AMBIENT TEMPERATURE

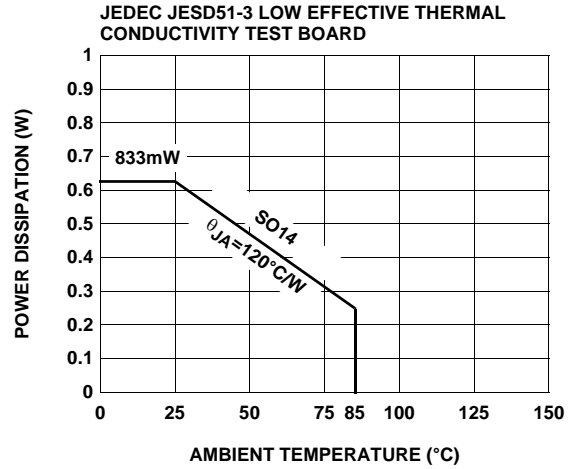

FIGURE 22. PACKAGE POWER DISSIPATION vs AMBIENT TEMPERATURE

Pin Descriptions

PIN NUMBER	PIN NAME	EQUIVALENT CIRCUIT	DESCRIPTION
1	IN0	Circuit 1	Input for channel 0
2, 6, 9	NIC		Not Internally Connected; it is recommended this pin be tied to ground to minimize crosstalk.
3	IN1	Circuit 1	Input for channel 1
4	GND	Circuit 4	Ground pin
5	IN2	Circuit 1	Input for channel 2
7	IN3	Circuit 1	Input for channel 3
8	V-	Circuit 4	Negative power supply
10	OUT	Circuit 3	Output
11	HIZ	Circuit 2	Output disable (active high); there are internal pull-down resistors, so the device will be active with no connection; "HI" puts the output in high impedance state.
12	S1	Circuit 2	Channel selection pin MSB (binary logic code)
13	S0	Circuit 2	Channel selection pin LSB (binary logic code)
14	V+	Circuit 4	Positive power supply
		<p>CIRCUIT 1.</p>	<p>CIRCUIT 2.</p>
		<p>CIRCUIT 3.</p>	<p>CIRCUIT 4.</p>

AC Test Circuits

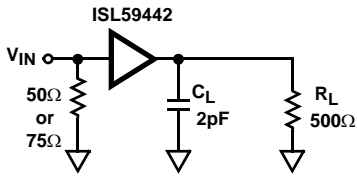

FIGURE 23A. TEST CIRCUIT WITH OPTIMAL OUTPUT LOAD

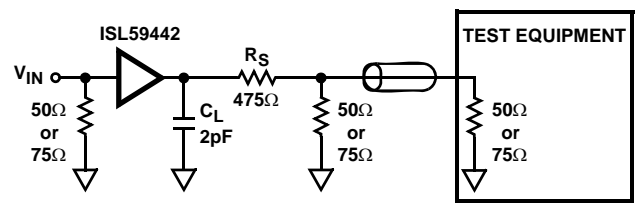

FIGURE 23B. TEST CIRCUIT FOR MEASURING WITH A 50Ω OR 75Ω INPUT TERMINATED EQUIPMENT

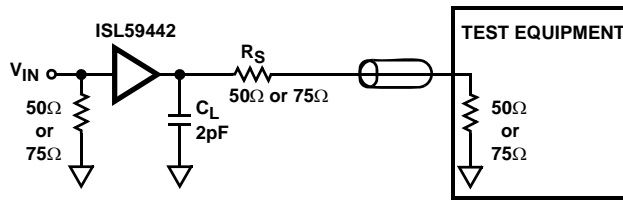

FIGURE 23C. BACKLOADED TEST CIRCUIT FOR VIDEO CABLE APPLICATION. BANDWIDTH AND LINEARITY FOR RL LESS THAN 500Ω WILL BE DEGRADED

NOTE: Figure 23A illustrates the optimum output load for testing AC performance. Figure 23B illustrates the optimum output load when connecting to input terminated equipment. Figure 23C illustrates back loaded test circuit for video cable.

Application Circuits

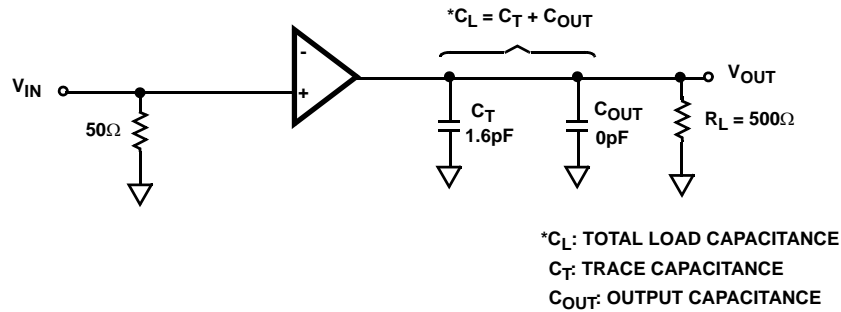

FIGURE 24A. SMALL SIGNAL 200mV_{p-p} APPLICATION CIRCUIT

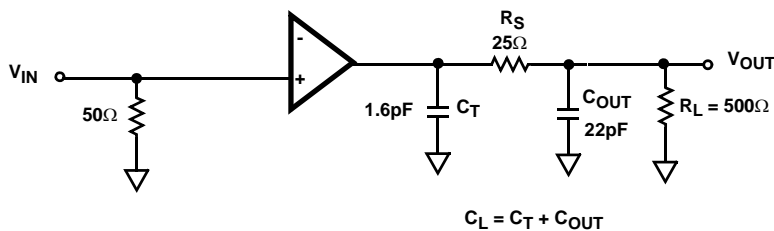

FIGURE 24B. LARGE SIGNAL 2V_{p-p} APPLICATION CIRCUIT

Application Information

General

The ISL59442 is a 4:1 mux that is ideal as a matrix element in high performance switchers and routers. The ISL59442 is optimized to drive a 2pF in parallel with a 500Ω load. The capacitance can be split between the PCB capacitance and external load capacitance. Their low input capacitance and high input resistance provide excellent 50Ω or 75Ω terminations.

Capacitance at the Output

The output amplifier is optimized for capacitance to ground (C_L) directly on the output pin. Increased capacitance causes higher peaking with an increase in bandwidth. The optimum range for most applications is ~1.0pF to ~6pF. The optimum value can be achieved through a combination of PC board trace capacitance (C_T) and an external capacitor (C_{OUT}). A good method to maintain control over the output pin capacitance is to minimize the trace length (C_T) to the next component, and include a discrete surface mount capacitor (C_{OUT}) directly at the output pin.

For large signal applications where overshoot is important the circuit in Figure 24B should be used. The series resistor (R_S) and capacitor (C_L) form a low pass network that limits system bandwidth and reduces overshoot. The component values shown result in a typical pulse response shown in Figure 20.

Ground Connections

For the best isolation and crosstalk rejection, the GND pin and NIC pins must connect to the GND plane. The NIC pins are placed on both sides of the input pins. These pins are not internally connected to the die. It is recommended this pin be tied to ground to minimize crosstalk.

Control Signals

S0, S1, HIZ - These pins are, TTL/CMOS compatible control inputs. The S0, S1 pins select which one of the inputs connect to the output. The HIZ pin is used to three-state the output amplifiers. For control signal rise and fall times less than 10nsec the use of termination resistors close to the part will minimize transients coupled to the output.

Power-Up Considerations

The ESD protection circuits use internal diodes from all pins the V+ and V- supplies. In addition, a dV/dT- triggered clamp is connected between the V+ and V- pins, as shown in the Equivalent Circuits 1 through 4 section of the Pin Description table. The dV/dT triggered clamp imposes a maximum supply turn-on slew rate of 1V/μs. Damaging currents can flow for power supply rates-of-rise in excess of 1V/μs, such as during hot plugging. Under these conditions, additional methods should be employed to ensure the rate of rise is not exceeded.

Consideration must be given to the order in which power is applied to the V+ and V- pins, as well as analog and logic input pins. Schottky diodes (Motorola MBR0550T or equivalent) connected from V+ to ground and V- to ground (Figure 25) will shunt damaging currents away from the internal V+ and V- ESD diodes in the event that the V+ supply is applied to the device before the V- supply.

If positive voltages are applied to the logic or analog video input pins before V+ is applied, current will flow through the internal ESD diodes to the V+ pin. The presence of large decoupling capacitors and the loading effect of other circuits connected to V+, can result in damaging currents through the ESD diodes and other active circuits within the device. Therefore, adequate current limiting on the digital and analog inputs is needed to prevent damage during the time the voltages on these inputs are more positive than V+.

HIZ State

An internal pull-down resistor connected to the HIZ pin ensures the device will be active with no connection to the HIZ pin. The HIZ state is established within approximately 30ns by placing a logic high (>2V) on the HIZ pin. If the HIZ state is selected, the output is a high impedance 1.4MΩ. Use this state to control the logic when more than one mux shares a common output.

In the HIZ state the output is three-stated, and maintains its high Z even in the presence of high slew rates. The supply current during this state is basically the same as the active state.

Limiting the Output Current

No output short circuit current limit exists on these parts. All applications need to limit the output current to less than 50mA. Adequate thermal heat sinking of the parts is also required.

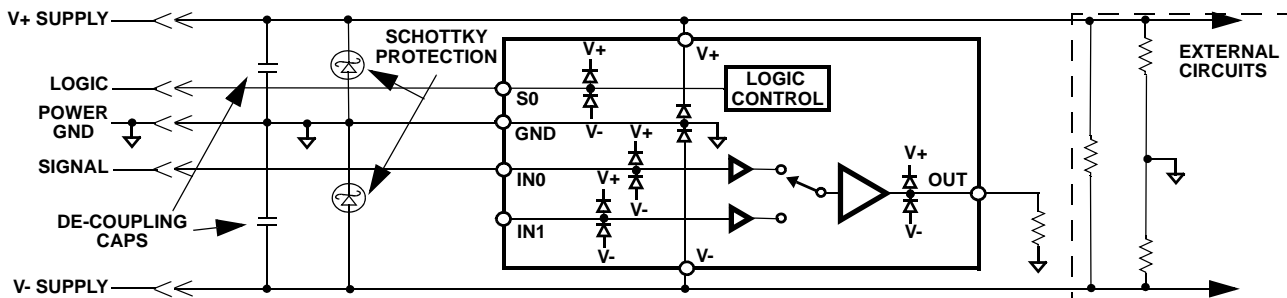

FIGURE 25. SCHOTTKY PROTECTION CIRCUIT

PC Board Layout

The frequency response of this circuit depends greatly on the care taken in designing the PC board. The following are recommendations to achieve optimum high frequency performance from your PC board.

- The use of low inductance components such as chip resistors and chip capacitors is strongly recommended.
- Minimize signal trace lengths. Trace inductance and capacitance can easily limit circuit performance. Avoid sharp corners, use rounded corners when possible. Vias in the signal lines add inductance at high frequency and should be avoided. PCB traces greater than 1" begin to exhibit transmission line characteristics with signal rise/fall times of 1ns or less. High frequency performance may be degraded for traces greater than one inch, unless strip lines are used.
- Match channel-channel analog I/O trace lengths and layout symmetry. This will minimize propagation delay mismatches.
- Maximize use of AC de-coupled PCB layers. All signal I/O lines should be routed over continuous ground planes (i.e. no split planes or PCB gaps under these lines). Avoid vias in the signal I/O lines.
- Use proper value and location of termination resistors. Termination resistors should be as close to the device as possible.
- When testing use good quality connectors and cables, matching cable types and keeping cable lengths to a minimum.
- Minimum of 2 power supply de-coupling capacitors are recommended (1000pF, 0.01 μ F) as close to the devices as possible. Avoid vias between the cap and the device because vias add unwanted inductance. Larger caps can be farther away. When vias are required in a layout, they should be routed as far away from the device as possible.
- The NIC pins are placed on both sides of the input pins. These pins are not internally connected to the die. It is recommended these pins be tied to ground to minimize crosstalk.

Small Outline Package Family (SO)

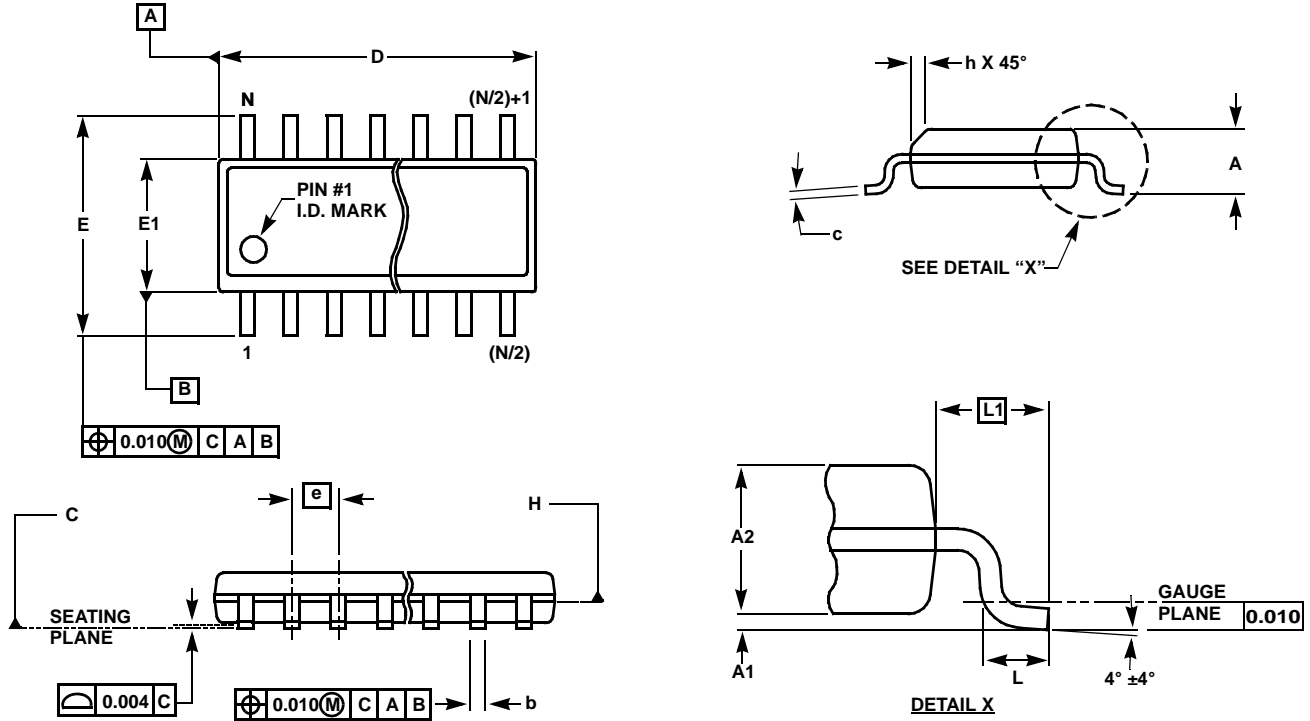

MDP0027

SMALL OUTLINE PACKAGE FAMILY (SO)

SYMBOL	SO-8	SO-14	SO16 (0.150")	SO16 (0.300") (SOL-16)	SO20 (SOL-20)	SO24 (SOL-24)	SO28 (SOL-28)	TOLERANCE	NOTES
A	0.068	0.068	0.068	0.104	0.104	0.104	0.104	MAX	-
A1	0.006	0.006	0.006	0.007	0.007	0.007	0.007	± 0.003	-
A2	0.057	0.057	0.057	0.092	0.092	0.092	0.092	± 0.002	-
b	0.017	0.017	0.017	0.017	0.017	0.017	0.017	± 0.003	-
c	0.009	0.009	0.009	0.011	0.011	0.011	0.011	± 0.001	-
D	0.193	0.341	0.390	0.406	0.504	0.606	0.704	± 0.004	1, 3
E	0.236	0.236	0.236	0.406	0.406	0.406	0.406	± 0.008	-
E1	0.154	0.154	0.154	0.295	0.295	0.295	0.295	± 0.004	2, 3
e	0.050	0.050	0.050	0.050	0.050	0.050	0.050	Basic	-
L	0.025	0.025	0.025	0.030	0.030	0.030	0.030	± 0.009	-
L1	0.041	0.041	0.041	0.056	0.056	0.056	0.056	Basic	-
h	0.013	0.013	0.013	0.020	0.020	0.020	0.020	Reference	-
N	8	14	16	16	20	24	28	Reference	-

Rev. L 2/01

NOTES:

1. Plastic or metal protrusions of 0.006" maximum per side are not included.
2. Plastic interlead protrusions of 0.010" maximum per side are not included.
3. Dimensions "D" and "E1" are measured at Datum Plane "H".
4. Dimensioning and tolerancing per ASME Y14.5M-1994

All Intersil U.S. products are manufactured, assembled and tested utilizing ISO9000 quality systems.
Intersil Corporation's quality certifications can be viewed at www.intersil.com/design/quality

Intersil products are sold by description only. Intersil Corporation reserves the right to make changes in circuit design, software and/or specifications at any time without notice. Accordingly, the reader is cautioned to verify that data sheets are current before placing orders. Information furnished by Intersil is believed to be accurate and reliable. However, no responsibility is assumed by Intersil or its subsidiaries for its use; nor for any infringements of patents or other rights of third parties which may result from its use. No license is granted by implication or otherwise under any patent or patent rights of Intersil or its subsidiaries.

For information regarding Intersil Corporation and its products, see www.intersil.com